

SHIPPING BIOLOGICAL SUBSTANCES AND PATIENT SPECIMENS



DO NOT prepare any international shipments before consulting with UNL Export Control at exportcontrol@unl.edu or call 402-472-6929.

This Standard Operating Procedure (SOP) describes how to prepare a shipment containing biological substances or patient specimens for transport by air with a carrier that subscribes to International Air Transport Authority (IATA) standards. The information in this SOP is based on the most current IATA Dangerous Goods Regulations.

This SOP is a supplement to and not a substitute for the DOT/IATA training provided by EHS. Training is required before engaging in any transport-related function and at least every three (3) years thereafter.

SCOPE

This SOP applies to shipments containing only the following dangerous goods/hazardous materials: 1) patient specimens (human or animal) with or without dry ice, and 2) biological substances with or without dry ice. Solutions of 10% buffered formalin are not considered dangerous goods/hazardous materials. Therefore, packages containing patient specimens or biological substances with 10% buffered formalin can be shipped in accordance with the instructions in this SOP.

Shipment of infectious substances or any other dangerous good/hazardous material other than that described above is beyond the scope of this SOP. Packages of patient specimens or biological substances containing 30 mL or less of certain flammable, corrosive or other hazard class 9 liquids must be packaged and shipped using this SOP in tandem with the EHS SOP, ***Shipping Excepted Quantities of Dangerous Goods***.

PROPER CLASSIFICATION

Dangerous Goods/Hazardous Materials must be properly classified and shipped in accordance with the appropriate packaging and shipping instructions. Do not over- or under- classify dangerous goods/hazardous materials.

Excepted Materials

Certain biological materials are not subject to any DOT/IATA regulations when offered for transport. These excepted materials should not be shipped as a Biological Substance or Patient Specimen, and are described below. Materials that are entirely excepted can be shipped with no special packaging, labeling, or shipping paperwork.

- Substances that do not contain infectious substances or substances that are unlikely to cause disease in humans or animals.
- Substances containing micro-organisms that are non-pathogenic to humans or animals.
- Substances in a form that any present pathogens have been neutralized or inactivated such that they no longer pose a health risk.
- Environmental samples (including food and water samples) that are not considered to pose a significant risk of infection.
- Dried blood spots, collected by applying a drop of blood onto absorbent material and/or fecal occult blood screening tests.
- Blood or blood components that have been collected for the purposes of transfusion or for the preparation of blood products to be used for transfusion or transplantation and any tissues or organs intended for use in transplantation.
- Biological products that are manufactured and packaged in accordance with the requirements of appropriate national authorities and transported for the purposes of final packaging or distribution and use for personal health care by medical professionals or individuals. Vaccines fall into this exception.

Infectious Substances, Category A

Materials that fall within this category are in a form that is capable of causing permanent disability, life-threatening or fatal disease in otherwise healthy humans or animals following exposure. Examples include pure cultures containing the causative agent of anthrax, hepatitis, and tuberculosis, and samples or other materials containing ebola and smallpox viruses. Materials properly classified as “Infectious Substances, Category A” must be shipped in accordance with the EHS SOP, ***Shipping Infectious Substances with or without Dry Ice***.

Patient Specimens

“Patient Specimens” are described as having minimal likelihood of pathogens being present, examples of which include: blood or urine tests to monitor cholesterol levels, blood glucose levels, hormone levels, or prostate specific antigens (PSA); tests required to monitor organ function such as heart, liver or kidney function for humans or animals with non-infectious diseases, or therapeutic drug monitoring; tests conducted for insurance or employment purposes and are intended to determine the presence of drugs or alcohol; pregnancy tests; biopsies to detect cancer; and antibody detection in humans or animals in the absence of any concern for infection (e.g., evaluation of vaccine induced immunity, diagnosis of autoimmune disease, etc.).

Biological Substance, Category B

A “Biological Substance, Category B” is defined by default as a dangerous good/hazardous material that does not meet the criteria/definition of an “Infectious Substance, Category A” and which is not excepted or properly classified as a “Patient Specimen.” Examples of materials properly classified as a “Biological Substance, Category B” include: clinical specimens (not cultures) suspected or

known to contain the causative agent of anthrax, rabbit fever, hepatitis, human immunodeficiency virus, and similar agents.

SAFETY INFORMATION

Patient Specimens

The definition of “Patient Specimens” recognizes that a small percentage of the human and animal populations are infected with diseases that can be transmitted to others through contact with infectious body fluids. The risk of disease transmission is dependent on a number of factors including characteristics of the infectious agents themselves and the mode of exposure. The highest risk of transmission is typically associated with needle-stick or similar injuries that involve penetration of the skin with a contaminated object. All factors considered, the risk of disease transmission through contact with a patient specimen is generally very small, but not zero.

Biological Substances

Materials properly classified as a “Biological Substance, Category B” typically pose somewhat more of a hazard to human or animal health than materials properly classified as “Patient Specimens.” In general, these materials are known or suspected of containing biological agents that can cause disease, but generally the disease is treatable and not life threatening with proper medical intervention. Inhalation is not generally the primary route of infection. Infection is usually by ingestion, contact with open wounds, or inoculation (skin abrasion with a contaminated object).

Protective Safety Measures for Patient Specimens and Biological Substances

- Handle all human and animal specimens with “universal precautions.” In general, this means that these materials are handled as if they were infectious.
- Avoid contact with unprotected skin, eyes, and mucous membranes. Use appropriate Personal Protective Equipment (PPE) (gloves, protective eyewear, and lab coat or other outer garment).
- Observe good personal hygiene (e.g., wash hands after removing PPE and before leaving the work area).
- Avoid aerosol-producing activities that could result in inhalation of infectious particles. Handle open containers in a Biosafety Cabinet.
- Seek immediate medical consultation following known or suspected exposures to potentially infectious materials, including body fluids, by a susceptible route of exposure (e.g., splash to the eye, needlestick or other skin penetrating injury with a contaminated object, etc.).
- Prior to preparing biological substances for shipment, review the Safety Data Sheet, agent hazard summary, or other reputable technical reference to familiarize yourself with the characteristics of the biological agents that can reasonably be expected to be present in the material being shipped.
- A freshly prepared 10% solution of household bleach with a contact time of 20 minutes is effective in disinfecting non-porous equipment, surfaces, and spills of

potentially infectious materials. Efficacy of disinfection is diminished in the presence of heavy organic loading (e.g., lots of dirt, grime, grease, etc.).

Dry Ice

Sometimes, biological substances or patient specimens are shipped with dry ice. Following is a broad summary of the hazards of small quantities (e.g., 5 pounds or less) of dry ice shipped in commerce.

- Dry ice sublimates. It changes directly from a solid to a gas. Therefore, outer packages and over-packs must not be tightly sealed. They must allow gases to escape to prevent build-up of pressure.
- As dry ice sublimates it creates carbon dioxide gas, which is colorless and odorless. If enough dry ice were to sublime in an unventilated space, it could accumulate to a level that exceeds an occupational exposure limit (5000 ppm, expressed as an 8 hour Time-Weighted Average (TWA) or 30,000 ppm as a ceiling limit). Breathing high concentrations of carbon dioxide can lead to labored breathing, increased pulse rate, headache, increased blood pressure, and muscle twitching. At extremely high concentrations, the amount of oxygen available could be reduced to an amount that is insufficient to support life, leading to asphyxiation.
- Dry ice is extremely cold at -109.3°F (-78.5°C). Touching dry ice unprotected can lead to frostbite. Always handle dry ice with care and wear thermally protective gloves and protective eyewear. Use mechanical device (e.g., tongs) to handle.

IATA 4.2 DANGEROUS GOODS TABLE

Following is information from the IATA 4.2 table for Biological Substances, Category B and Dry Ice.

Biological Substance, Category B	
Proper shipping name	Biological Substance, Category B
UN/ID No.	UN3373
Class or Division	6.2
Hazard Label	Not Applicable
Packing Group	Not Applicable
Packing Instruction	650
Maximum Quantity/Package for Limited Quantity Shipment	"E0"- Not permitted as Excepted Quantity
Passenger/Cargo Aircraft (quantity limitations)	Liquid: 1 L/inner package; 4L/outer package Solid: 4Kg/outer package

Cargo Aircraft Only (quantity limitations)	Liquid: 1 L/inner package; 4L/outer package Solid: 4Kg/outer package
Special Provisions	None

Dry Ice	
Proper shipping name:	“Carbon dioxide, solid” or “Dry ice”
UN/ID No.:	UN 1845
Class or Division	9
Hazard Label	Miscellaneous
Packing Group	Not Applicable
Packing Instructions	954
Maximum Quantity/Package for Limited Quantity Shipment	“E0”- Not permitted as Excepted Quantity
Passenger/Cargo Aircraft (quantity limitations)	200 kg
Cargo Aircraft Only (quantity limitations)	200 kg
Special Provisions	A48 (package test not required); A151; A805

The entry for “Exempt animal specimen” and “Exempt human specimen in the IATA 4.2 table references IATA section 3.6.2.2.3.8. There are no column entries in the table.

PACKAGING - BIOLOGICAL SUBSTANCES, CATEGORY B

The packaging ensemble for *Biological Substances, Category B* materials must meet certain pressure and drop test requirements. Therefore, commercially-available packaging systems must be used (you can't assemble your own). Packaging must consist of three components:

1. Primary receptacle(s) that is/are leak- or sift-proof (liquids or solids, respectively) and have positive means of closure (e.g., tape reinforced lid closure);
2. Secondary packaging that is/are leak- or sift-proof (liquids or solids, respectively) and have positive means of closure (e.g., tape reinforced lid closure); and
3. Rigid outer packaging. If dry ice is included in the package, then the outer package must be designed and closed in a manner that will allow off-gassing vapors to escape.

In addition,

1. Minimum outside dimensions of at least one surface of the package is 4” x 4”.
2. Inner packages containing liquids must have sufficient headspace to allow for expansion of the liquid due to temperature/pressure changes.
3. Inner packages must be packed, secured, or cushioned against leakage and/or breakage.
4. Packages cannot be vented except for the venting of dry ice.
5. Packages containing liquids must be orientated with the closures in an upright position, and sufficient absorbent placed between the primary and secondary containers to absorb the entire content. The maximum quantity for each primary

- receptacle is 1 Liter for liquids. Maximum quantities for outer packages are 4 Liters for liquids and 4 Kilograms for solids (excluding the weight of dry ice).
6. Other dangerous goods must not be packed in the same packaging with *Biological Substances, Category B* unless they are necessary for maintaining viability, stabilizing or preventing degradation, or neutralizing the hazards of potentially infectious substances; and then the quantity is limited to thirty (30) ml or less of Class 3 (flammable and combustible liquids), 8 (corrosive), or 9 (miscellaneous) per each primary receptacle. If the package will contain this type of material, use the instructions in this SOP in tandem with the instructions found in the EHS SOP, ***Shipping Excepted Quantities of Dangerous Goods***.
 7. An itemized list of the contents must be included between the primary and secondary packaging.

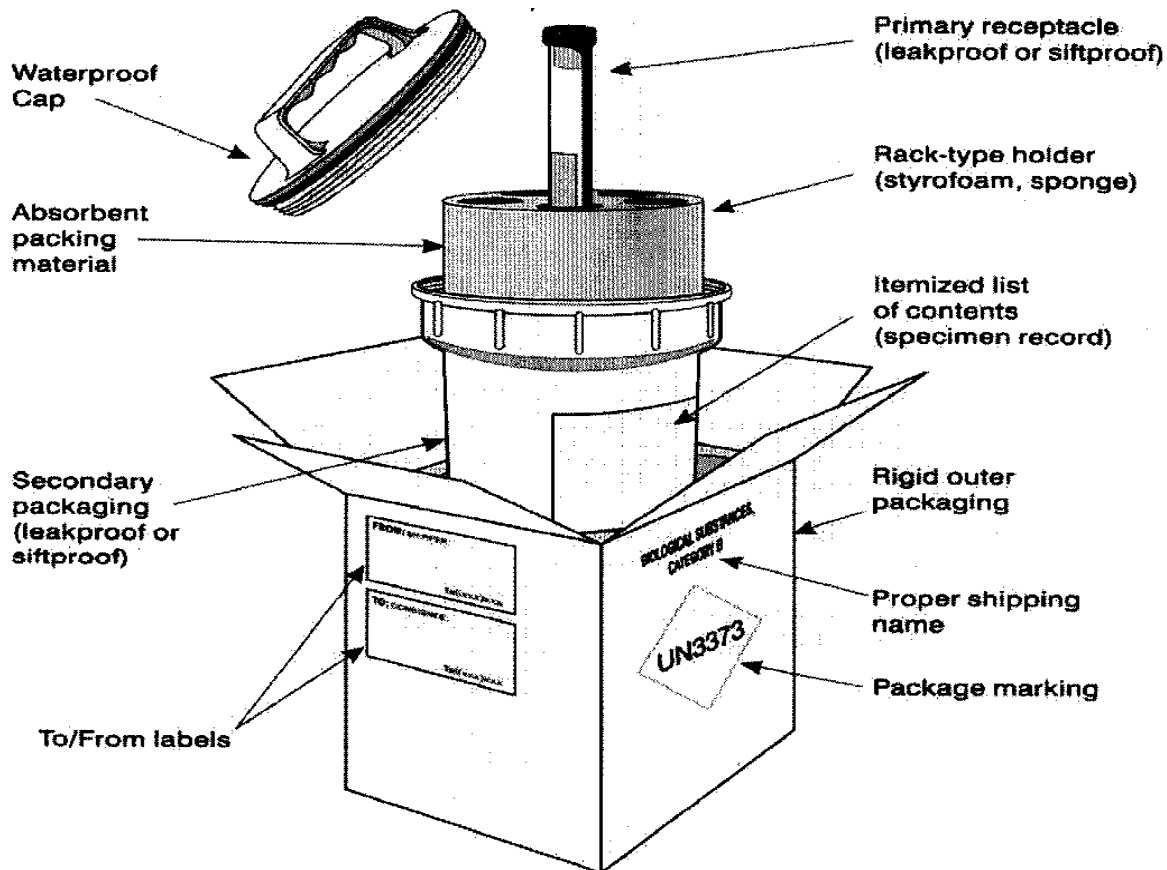

MARKING & LABELING - BIOLOGICAL SUBSTANCES, CATEGORY B

General marking and labeling requirements must be observed, such as: all markings must be in English; all markings and labels must be durable and in the correct location with no overlapping or folding from one surface dimension of the package to the other, and; only relevant markings and labels are allowed. The following marking and labeling is required on the outer package:

1. Complete name and address of the shipper. The shipper's telephone number must also be recorded on the outer container. This does not need to be a 24-hour emergency response number but should be for someone who is knowledgeable of the potential hazards of the shipment.
2. Complete name and address of the consignee.
3. The proper shipping name (*Biological Substance, Category B*) in letters at least 6 mm (about ¼ inch) high. If dry ice is included, the package must also contain the additional UN number, proper shipping name (UN1845, Dry Ice), and net amount of dry ice in the package (in Kilograms).
4. A diamond of the minimum specified size containing the UN3373 designation.
5. A miscellaneous hazard class 9 label, if the package contains dry ice.
6. The word "Overpack" if applicable.
7. "Orientation" arrows if the package contains liquids.
8. If excepted quantities of dangerous goods are packed with the Biological Substance, Category B, add additional marking and labeling as described in the EHS SOP, ***Shipping Excepted Quantities of Dangerous Goods***.

Example Packages - See Appendix A

DOCUMENTATION - BIOLOGICAL SUBSTANCES, CATEGORY B

A "Shippers Declaration of Dangerous Goods" is not required. An airway bill containing the following information is required:

- UN number and proper shipping name (*UN3373, Biological Substance, Category B*)
- The number of packages being shipped.
- The appropriate box checked to indicate that the shipment contains dangerous goods, but a declaration is not required.
- Name of the person preparing the shipment if different from the name recorded as the consignor/shipper.
- A copy of the airway bill must be retained by the shipper for at least 2 years.

Example Documentation - See Appendix A

PACKAGING – PATIENT SPECIMENS

Specification packaging is not required, but it must be of good quality, compatible with the contents and shipping conditions (e.g., temperature, humidity), and consist of three components:

1. Primary receptacle(s) that is/are leak- or sift-proof (liquids or solids, respectively) and have positive means of closure (e.g., tape reinforced lid closure);
2. Secondary packaging that is/are leak- or sift-proof (liquids or solids, respectively) and have positive means of closure (e.g., tape reinforced lid closure); and
3. Rigid outer packaging. If dry ice is included in the package, then the outer package must be designed and closed in a manner that will allow off-gassing vapors to escape.

In addition,

1. Inner packages must be packed, secured, or cushioned against leakage and/or breakage.
2. Packages cannot be vented except for the venting of dry ice.
3. Packages containing liquids must be orientated with the closures in an upright position, and sufficient absorbent placed between the primary and secondary containers to absorb the entire content.
4. Other dangerous goods (other than Dry Ice) must not be packed in the same packaging with patient specimens. If Excepted Quantities of Dangerous Goods are packed with the patient specimens, refer to the EHS SOP, **Shipping Excepted Quantities of Dangerous Goods**. More robust packaging is required for shipments of patient specimens and dangerous goods in excepted quantities.

MARKING & LABELING – PATIENT SPECIMENS

The following marking and labeling is required on the outer package:

1. Complete name and address of the shipper.
2. Complete name and address of the consignee.
3. Packages must be marked as “Exempt human specimen” or “Exempt animal specimen” as appropriate.

Section 3.6.2.2.3 of the IATA regulations contain no other requirements pertaining to labeling or marking.

Example Packages - See Appendix A

DOCUMENTATION – PATIENT SPECIMENS

A “Shippers Declaration of Dangerous Goods” is not required. An airway bill is required and must include the words “Exempt human specimen” or “Exempt animal specimen,” as appropriate. If dry ice is not contained in the package, section six of the airway bill must be checked NO in response to the question “Does this shipment contain dangerous goods?” If dry ice is included in the package, section six of the airway bill must be checked YES and indicate that a “Shipper’s declaration not required” in response to the question “Does this shipment contain dangerous goods?”

Example Documentation - See Appendix A

Security Awareness Training Reminder

Hazmat employees must receive training relative to security. Following is a summary of the security awareness information included in the EHS IATA training program. Reduce the possibility of unauthorized access, possession, and use by securing all hazardous materials/dangerous goods. The following general guidelines represent minimum requirements:

- Packages containing hazardous materials/dangerous goods must be kept in a secured area, or under the supervision of a designated shipper, or other

authorized employee(s) until picked up by the carrier. Limit access to areas where dangerous goods/hazardous materials packages are prepared for shipment, received, stored, unpacked or used to authorized employees only. Report latches and locks on doors or other security devices that are damaged, sticky, or have been tampered to your supervisor and the Building Maintenance Reporter.

- Make sure the carrier picking up dangerous goods/hazardous materials shipments has identification (e.g., company ID, uses a clearly identified company vehicle, or wears a company uniform).
- Report suspicious individuals, behavior, stolen or missing dangerous goods/hazardous materials, and known or suspected unauthorized entry into secured areas to your supervisor and to the UNL Police Department 402-472-2222. Be aware of your surroundings; look for out-of-place vehicles and abandoned or out-of-place backpacks, bags, or other containers.
- Limit information concerning hazardous materials/dangerous goods shipments to individuals who need to know, such as other authorized employees, carrier personnel, and supervisors. Do not share information on dangerous goods/hazardous materials shipments with casual acquaintances or strangers.
- Be familiar with emergency procedures in place at UNL and know what to do if a package is leaking or damaged.

APPENDIX A EXAMPLE PACKAGES AND DOCUMENTATION – BIOLOGICAL SUBSTANCES, CATEGORY B

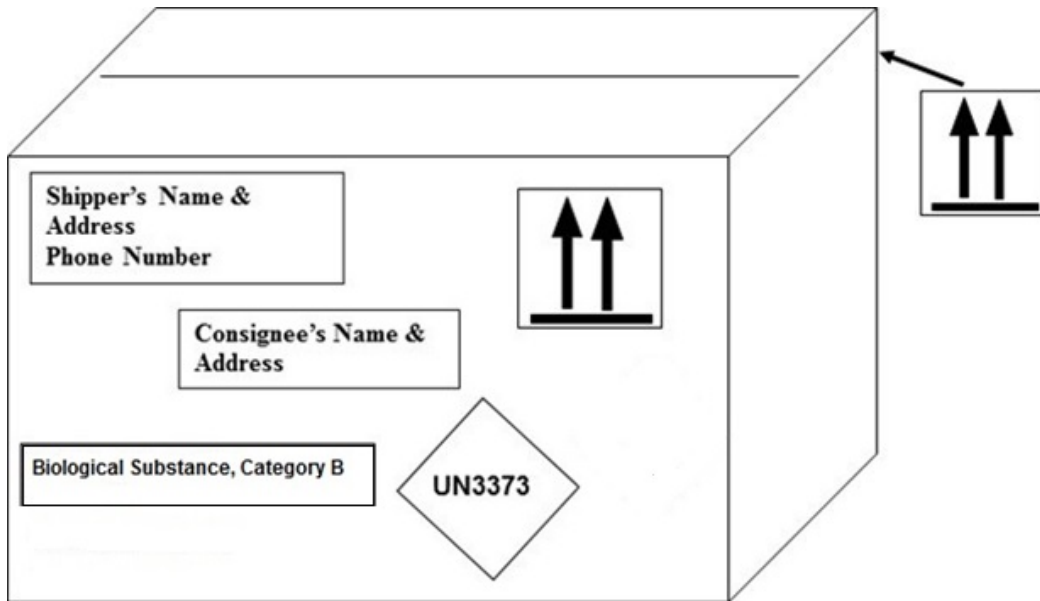

The example above is for a package containing a material properly classified as Biological Substance, Category B and no other dangerous good in the package or containing a material that is not regulated (e.g., 10% buffered formalin).

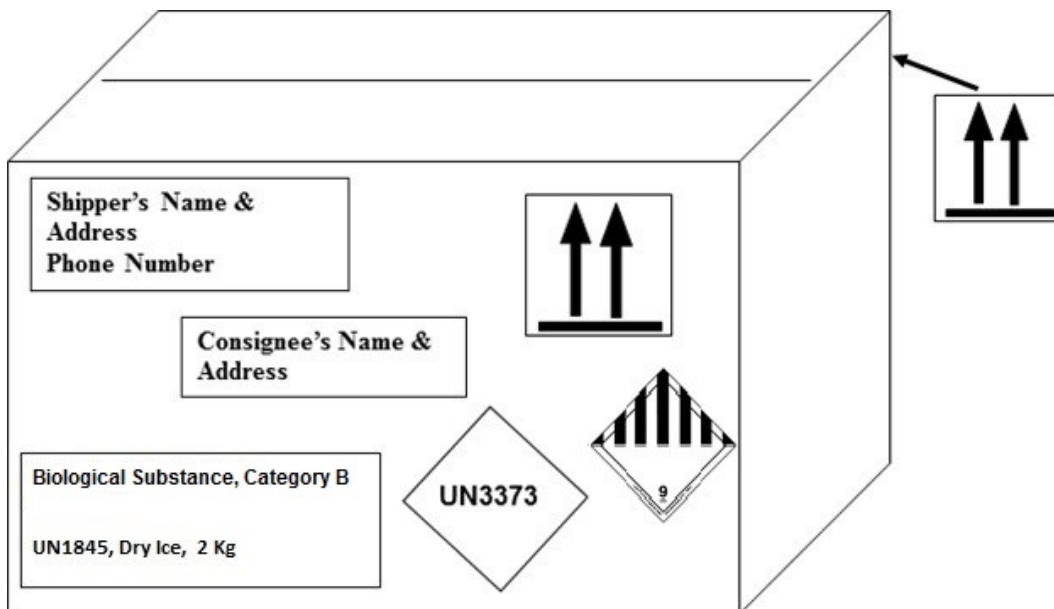

The example above is for a package containing a material properly classified as Biological Substance, Category B that also contains Dry Ice.

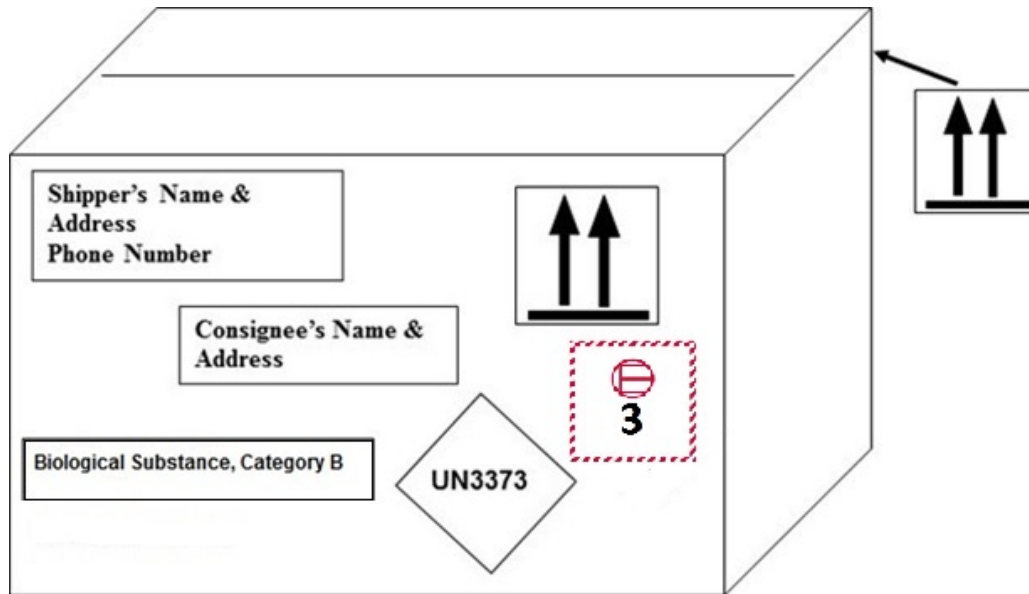

The example above is for a package containing a material properly classified as Biological Substance, Category B that also contains 30 ml or less of a flammable liquid (e.g., ethanol) in each primary receptacle (500 ml maximum net quantity per outer package). If the package contained a corrosive liquid (class 8) or miscellaneous liquid (class 9) the Excepted Package Mark would show an 8 or 9 respectively instead of the 3.

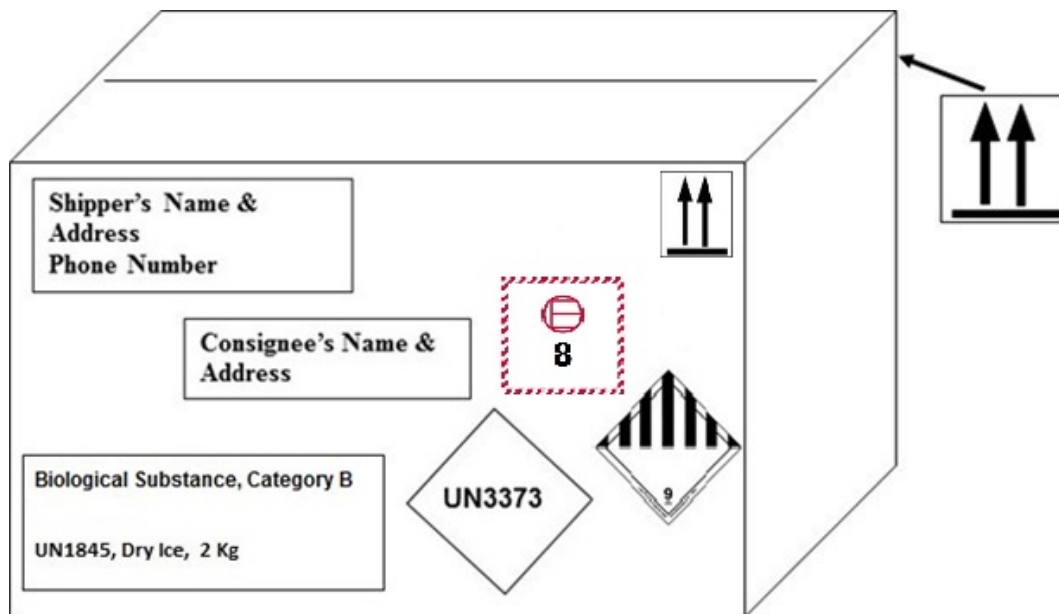

The example above is for a package containing a material properly classified as Biological Substance, Category B that also contains 30 ml or less of a hazard class 8 substance (e.g., 25% formaldehyde) in each primary receptacle (500 ml maximum net quantity per outer package), and Dry Ice. If this example used a flammable liquid (class 3) or miscellaneous liquid (class 9) the Excepted Package Mark would show a 3 or 9 respectively instead of the 8.

FedEx. US Airbill Express

0200 Sender's Copy

1 **From** (Person or Company)
 Date: 9-23-2005 Sender's FedEx Account Number: 1234567890

Sender's Name: Ann Smith Phone: 402-472-0000
 Company: University of Nebraska-Lincoln EHS
 Address: 3630 E. Campus Loop
 City: Lincoln State: NE ZIP: 68583-0824

2 **Your Internal Billing Reference**

3 **To**
 Recipient's Name: Marge Harley Phone: 000 1 000-0000
 Company: MSD Inc.
 Recipient's Address: 6075 S. Spencer
 City: Las Vegas State: NV ZIP: 89109

**UN3373, BIOLOGICAL SUBSTANCE, CATEGORY B
 ONE PACKAGE**
Dangerous Goods in Excepted Quantities

[try online shipping at fedex.com](http://www.fedex.com)

4a **Express Package Service** Packages up to 10 lbs.
 FedEx Priority Overnight
 FedEx Standard Overnight
 FedEx Next Business Day

4b **Express Freight Service** Packages over 10 lbs.
 FedEx 1Day Freight
 FedEx 2Day Freight
 FedEx 3Day Freight

5 **Packaging**
 FedEx Envelope
 FedEx Flat
 FedEx Box
 FedEx Tube
 Other

6 **Special Handling**
 K100 Winter Delivery
 K100 Winter Protection
 K100 Saturday
 No
 Yes
 Dry Ice
 Carg. Secured Only

7 **Payment Method**
 Sender's Account
 Recipient
 Third Party
 Credit Card
 Cash/Check

Total Packages	Total Weight	Total Declared Value
1	4 lbs	\$ 0

8 **Sign to Authorize Delivery Without a Signature**

467

The example above is for a shipment containing all of the following: Biological Substance, Category B, Dry Ice, and Dangerous Goods in Excepted Quantities. Section 6 of the airway bill must indicate the quantity of dry ice (in kilograms), if included in the package. The proper shipping name and UN number for Biological Substance Category B must also be recorded on the airway bill. The airway bill must also include the words "Dangerous Goods in Excepted Quantities" if included in the package. If the package does not contain Dry Ice, then omit the information in section 6 relative to dry ice. If the package does not contain Dangerous Goods in Excepted Quantities, omit this language from the airway bill.

EXAMPLE PACKAGES AND DOCUMENTATION – PATIENT SPECIMENS

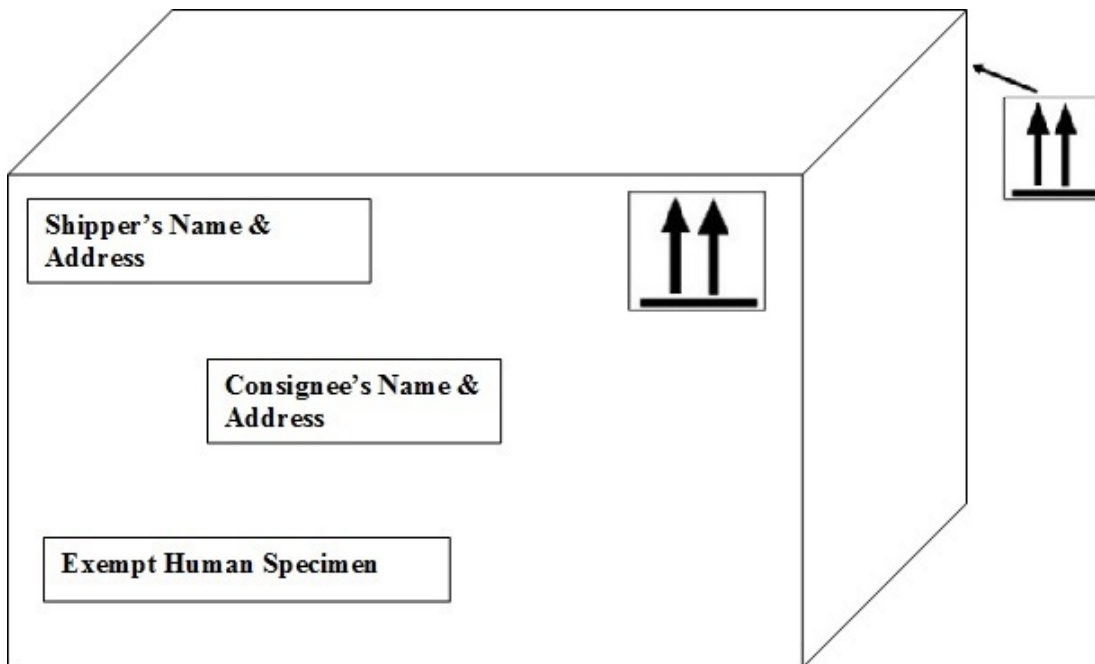

The example above is for a package containing a material properly classified as Exempt Human Specimen and no other dangerous good in the package or containing a material that is not regulated (e.g., 10% buffered formalin).

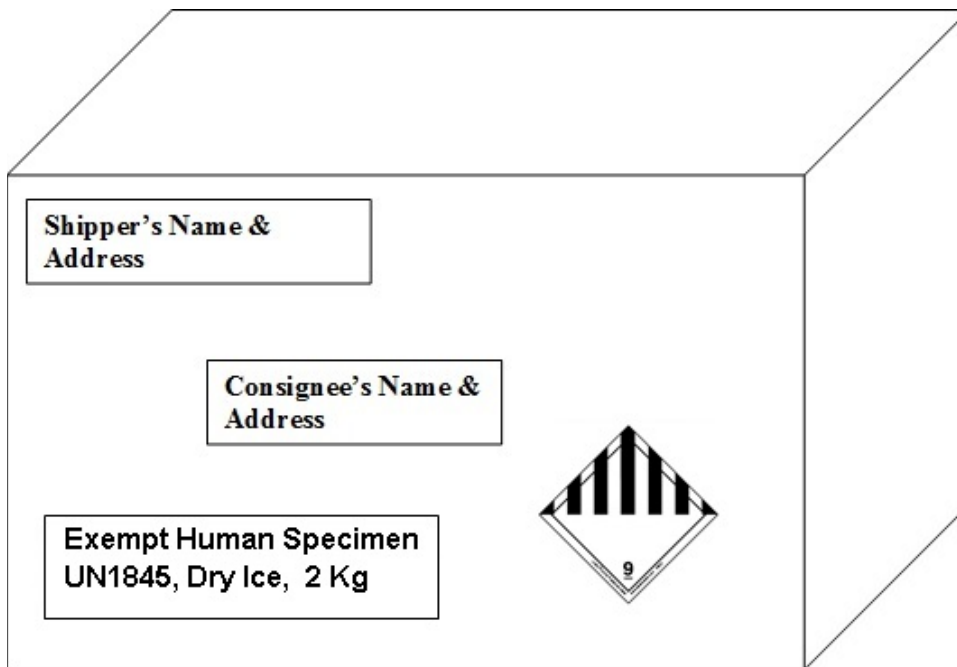

The example above is for a package containing a material properly classified as Exempt Human Specimen that also contains Dry Ice.

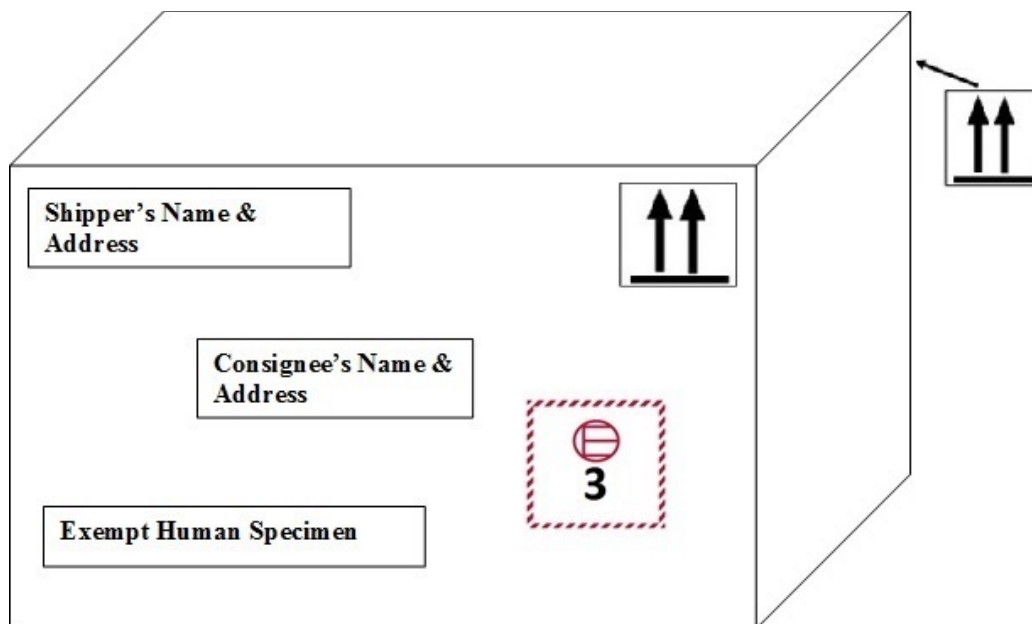

The example above is for a package containing a material properly classified as Exempt Human Specimen that also contains 30 ml or less of a flammable liquid (e.g., ethanol) in each primary receptacle (500 ml maximum net quantity per outer package). If this example used a corrosive liquid (class 8) or miscellaneous liquid (class 9) the Excepted Package Mark would show an 8 or 9 respectively instead of the 3.

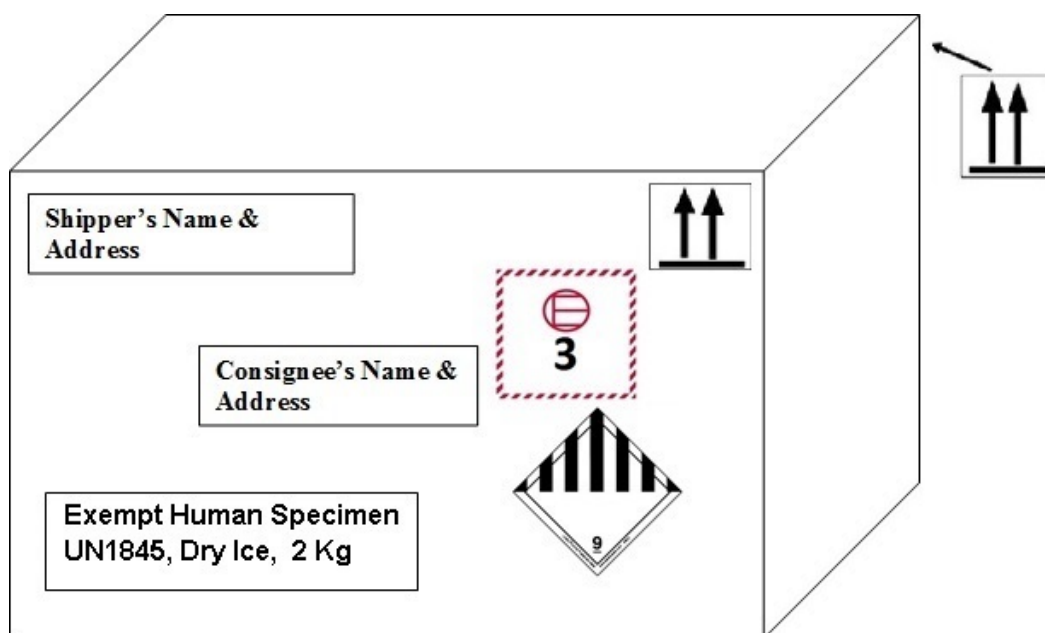

The example above is for a package containing a material properly classified as Exempt Human Specimen that also contains 30 ml or less of a flammable liquid (e.g., ethanol) in each primary receptacle (500 ml maximum net quantity per outer package), and Dry Ice. If the package contained a corrosive liquid (class 8) or miscellaneous liquid (class 9) the Excepted Package Mark would show an 8 or 9 respectively instead of the 3.

FedEx US Airbill Express Tracking Number **8531 5774 6190** **0200** Sender's Copy

1 From (Please print in ink)
 Date **9-23-2005** Sender's FedEx Account Number **1234567890**
 Sender's Name **Ann Smith** Phone **402-472-0000**
 Company **University of Nebraska-Lincoln EHS**
 Address **3630 E. Campus Loop**
 City **Lincoln** State **NE** ZIP **68583-0824**

2 Your Internal Billing Reference **Ann Smith**

3 To
 Recipient's Name **Marge Harley** Phone **000 1 000-0000**
 Company **MBD Inc.**
 Recipient's Address **6075 S. Spencer**
 Address
 City **Las Vegas** State **NV** ZIP **89109**

Exempt Human Specimen
 Try online shipping at fedex.com
Dangerous Goods in Excepted Quantities
1 Package

4a Express Package Service Packaged up to 150 lbs.
 FedEx Priority Overnight (Next business day)
 FedEx Standard Overnight (Next business day)
 FedEx First Overnight (Next business day)
 FedEx 2Day (Second business day)
 FedEx Express Saver (Business days)

4b Express Freight Service Packages over 150 lbs.
 FedEx 1Day Freight (Next business day)
 FedEx 2Day Freight (Second business day)
 FedEx 3Day Freight (Third business day)

5 Packaging
 FedEx Envelope
 FedEx Pak
 FedEx Box
 FedEx Tube
 Other

6 Special Handling (Include FedEx address in Section 3)
 SATURDAY Delivery Available ONLY for FedEx Priority Overnight, FedEx 2Day, FedEx 1Day Freight and FedEx 2Day Freight (under ZIP codes)
 HOLD Weekday at FedEx Location NOT Available for FedEx First Overnight
 HOLD Saturday at FedEx Location Available ONLY for FedEx Priority Overnight and FedEx First Overnight
 Does this shipment contain dangerous goods?
 No Yes (per styrofoam) Yes (per styrofoam) Dry Ice (by air only) **1, 2**
 Dangerous goods (including Dry Ice) cannot be shipped in FedEx packages. Cargo Aircraft Only

7 Payment \$/lb for: Letter FedEx App. No. or Credit Card No. below.
 Sender (bill to me) Recipient Third Party Credit Card Cash/Check

Total Packages	Total Weight	Total Declared Value*
1	4 lbs	\$ 0.00

8 Sign to Authorize Delivery Without a Signature
 By giving you authority to deliver this shipment without obtaining a signature and agree to indemnify and hold us harmless from any resulting claims. **467**

The example above is for a shipment containing all of the following: Exempt Human Specimen, Dry Ice, and Dangerous Goods in Excepted Quantities. Section 6 of the airway bill must indicate the quantity of dry ice (in kilograms), if included in the package. The words "Exempt Human Specimen" must appear on the airway bill. The airway bill must also include the words "Dangerous Goods in Excepted Quantities" if included in the package. If the package does not contain Dry Ice, then omit the information in section 6 relative to dry ice. If the package does not contain Dangerous Goods in Excepted Quantities, omit this language from the airway bill.